

# 中心鑽 >>>

i-Center是耐久的註冊商標，  
世界首創刀片式中心鑽，擁有多國專利  
只要在使用首次設定刀具長度，大幅提昇換刀效率

**P M K N**

- 2 個切削槽設計與鎢鋼中心鑽相同，可實現高速度與高進給
- 每片刀片有2個切削刃口

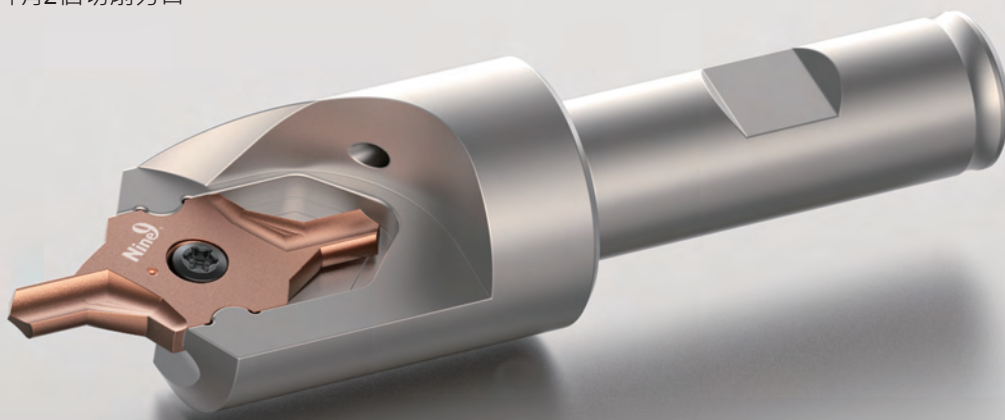

## Features >>>

- ▶ **高速度，高進給**
  - 高強度刀桿，高強度刀片
  - 合金鋼可使用6000rpm · 600mm/min ( 0.1mm/rev. )
- ▶ **優異的重現性**
  - 重現度0.02mm
- ▶ **刀具長度穩定**
  - 刀片更換，刀長誤差在0.05mm以內
- ▶ **優異的刀具壽命**
  - 使用中心出水，可以大幅提高刀具壽命
  - 刀片幾何形狀設計優化，刀片材種和鍍層，均是最適合中心孔加工使用



# Applications

優異的刀片重現性，  
更換刀片不用重新設定  
刀具長度



DIN 332 Form R

Ø1.0~Ø10

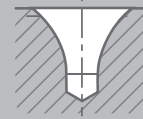

DIN 332 Form A

Ø2.0~Ø3.15

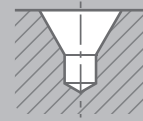

DIN 332 Form A+B

Ø1.0~Ø10

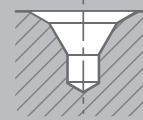

ANSI 60°

#2.0~#10

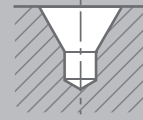

2

中心鑽

“世界首創刀片式中心鑽  
大幅縮短設定時間，減少加工工時  
刀具壽命增加，刀具成本降低。”

• 中心出水孔使高壓冷卻液快速直達切削刃口。

NC2057



- P35 鎢鋼底材, AL(L) 鍍層
- 適合鋼料，不鏽鋼及鑄鐵
- 雙刃切削設計

NC5074



- P40 鎢鋼底材，HELICA鍍層
- 特別適合小尺寸的I-Center (如IC08刀片)

NC2033



- K20F 鎢鋼底材，TIALN鍍層
- 適合鋼鐵，鑄鐵

# DIN332 R型刀片

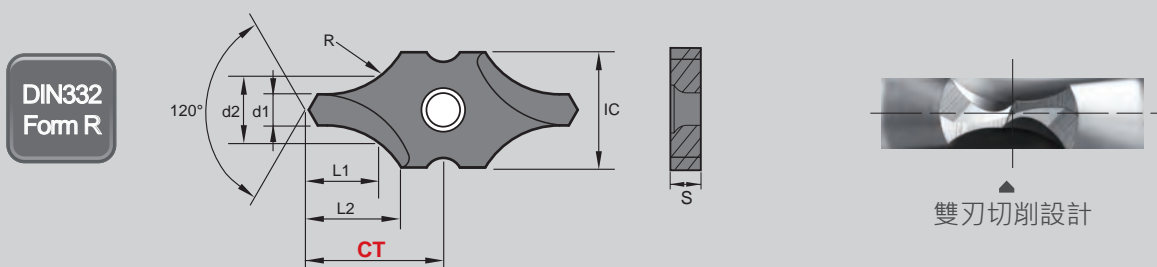

▶ DIN332 R型 >>

2

中心鑽

IC	訂購編號	鍍層	材質	d1	d2	L1	L2	R	S	CT ±0.025	
08	I9MT08T1R0100-NC5074	Helica	P40	1.00	+0.14 0	2.12	2.16	4.14	2.8	2.00	7.55
	I9MT08T1R0125-NC5074			1.25		2.65	2.74	4.64	3.5		7.90
	I9MT08T1R0160-NC5074			1.60		3.35	3.45	5.13	4.5		8.40
	I9MT08T1R0200-NC5074			2.00		4.25	4.45	6.08	5.65		9.10
10	I9MT1003R0100-NC2057	AlTiN+ TiSiN	P35	1.00	+0.14 0	2.12	2.16	4.72	2.8	3.00	12.35
	I9MT1003R0125-NC2057			1.25		2.65	2.74	5.22	3.5		
	I9MT1003R0150-NC2057			1.50		3.60	3.67	6.14	5.0		
	I9MT1003R0160-NC2057			1.60		3.35	3.45	5.32	4.5		
	I9MT1003R0200-NC2057			2.00	4.25	4.45	6.50	5.65			
	I9MT1003R0250-NC2057			2.50	5.30	5.59	7.66	7.15			
	I9MT1003R0300-NC2057			3.00	+0.18 0	5.70	6.92	9.50	10.00		
	I9MT1003R0315-NC2057			3.15	6.70	7.21	8.93	9.00			
12	I9MT12T2R0200-NC2033	TiAlN	K20F	2.00	+0.14 0	4.25	4.45	6.64	5.65	2.54	11.73
	I9MT12T2R0250-NC2033			2.50	5.3	5.59	8.11	7.15	13.00		
	I9MT12T2R0315-NC2033			3.15	6.7	7.21	9.63	9.0	14.00		
16	I9MT1603R0400-NC2033	TiAlN	K20F	4.00	+0.18 0	8.5	9.06	12.23	11.0	3.18	19.40
	I9MT1603R0500-NC2033			5.00	10.6	11.45	14.2	14.0	19.40		
20	I9MT2004R0630-NC2033	TiAlN	K20F	6.30	+0.22 0	13.2	14.63	18.2	18.0	4.76	28.40
	I9MT2004R0800-NC2033			8.00		17.0	18.63	20.44	22.5		28.30
25	I9MT2506R1000-NC2033	TiAlN	K20F	10.00		21.2	23.51	25.8	28.0	6.35	34.20

★ 接受IC32特製尺寸刀片，刀桿細節請詳見2-54頁。

# DIN332 A+B型刀片

DIN332  
Form A+B

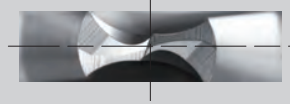
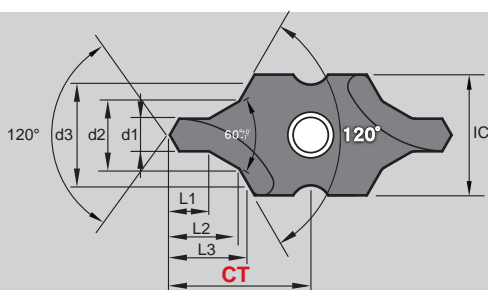

雙刃切削設計



► DIN332 A+B型 >>

2

中心鑽

IC	訂購編號	鍍層	材質	d1		d2	d3	L1	L2	L3	S	CT ±0.025
08	I9MT08T1B0100-NC5074	Helica	P40	1.00	+0.14 0	2.12	3.15	1.3	2.21	2.51	2.00	7.55
	I9MT08T1B0125-NC5074			1.25		2.65	4.0	1.6	2.75	3.14		7.90
	I9MT08T1B0160-NC5074			1.60		3.35	5.0	2.0	3.46	3.93		8.40
	I9MT08T1B0200-NC5074			2.00		4.25	6.3	2.5	4.39	4.98		9.10
10	I9MT1003B0100-NC2057	AlTiN+ TiSiN	P35	1.00	+0.14 0	2.12	3.15	1.3	2.21	2.51	3.00	12.35
	I9MT1003B0125-NC2057			1.25		2.65	4.0	1.6	2.75	3.14		
	I9MT1003B0150-NC2057			1.50		3.18	4.50	2.0	3.45	3.84		
	I9MT1003B0160-NC2057			1.60		3.35	5.0	2.0	3.46	3.93		
	I9MT1003B0200-NC2057			2.00	4.25	6.3	2.5	4.39	4.98			
	I9MT1003B0250-NC2057			2.50	5.3	8.0	3.1	5.53	6.28			
	I9MT1003B0300-NC2057			3.00	+0.18 0	6.46	9.00	4.1	7.10	7.83		
	I9MT1003B0315-NC2057			3.15		6.7	10.0	3.9	6.90	7.85		
12	I9MT12T2B0200-NC2033	TiAlN	K20F	2.00	+0.14 0	4.25	6.3	2.5	4.39	4.98	2.54	11.73
	I9MT12T2B0250-NC2033			2.50		5.3	8.0	3.1	5.53	6.28		13.0
	I9MT12T2B0315-NC2033			3.15		6.7	10.0	3.9	6.90	7.85		14.0
16	I9MT1603B0400-NC2033	TiAlN	K20F	4.00	+0.18 0	8.5	12.5	5.0	8.9	10.03	3.18	19.4
	I9MT1603B0500-NC2033			5.00		10.6	16.0	6.3	11.15	12.68		19.4
20	I9MT2004B0630-NC2033	TiAlN	K20F	6.30	+0.22 0	13.2	18.0	8.0	13.98	15.33	4.76	28.4
	I9MT2004B0800-NC2033			8.00		17.0	*20	10.1	17.89	18.73		28.3
25	I9MT2506B1000-NC2033	TiAlN	K20F	10.00	+0.22 0	21.2	*25	12.8	22.5	23.57	6.35	34.2

★ 接受IC32特製尺寸刀片，刀桿細節請詳見2-54頁。

\* 注意：d3尺寸與標準DIN332中心孔不同。

# DIN332 A型、ANSI 60°刀片

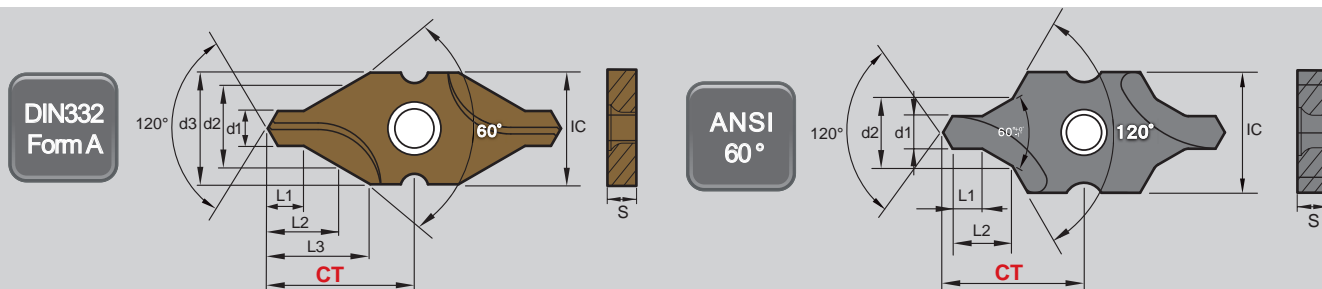

2

中心鑽



▶ DIN332 A型 >>

IC	訂購編號	鍍層	材質	d1		d2	d3	L1	L2	L3	S	CT ±0.025
08	I9MT08T1A0200-NC5074	Helica	P40	2.0	+0.14 0	4.25		2.15	4.10	7.35	2.00	10.5
	2.5			5.3								
	I9MT08T1A0315-NC5074			3.15	+0.18 0	6.7		3.23	6.30	7.43		



▶ ANSI 60° >>

IC	訂購編號	鍍層	材質	尺寸	d1		d2		L1		L2	S	CT ±0.025	
						mm		mm		mm	mm			
12	I9MT12T2A2-NC2033	TiAlN	K20F	#2	5/64	1.98	+0.14 0	3/16	4.76	5/64	1.98	4.4	12.6	
	I9MT12T2A3-NC2033			#3	7/64	2.78		1/4	6.35	7/64	2.78	5.9	2.54	13.8
	I9MT12T2A4-NC2033			#4	1/8	3.18		5/16	7.94	1/8	3.18	7.3		14.25
16	I9MT1603A5-NC2033	TiAlN	K20F	#5	3/16	4.76	+0.18 0	7/16	11.11	3/16	4.76	10.3	3.18	20.0
I9MT2004A6-NC2033	#6			7/32	5.56	1/2		12.7	7/32	5.56	11.8		27.75	
20	I9MT2004A7-NC2033			#7	1/4	6.35		5/8	15.88	1/4	6.35	14.6	4.76	28.5
	I9MT2004A8-NC2033	#8	5/16	7.94	+0.22 0	3/4	19.05	5/16	7.94	17.6		29.0		
25	I9MT2506A10-NC2033	#10	3/8	9.53		0.98"	25.0	3/8	9.53	22.9	6.35	34.9		

# IC10 60°, 90°, 120° 中心孔 & 埋頭孔

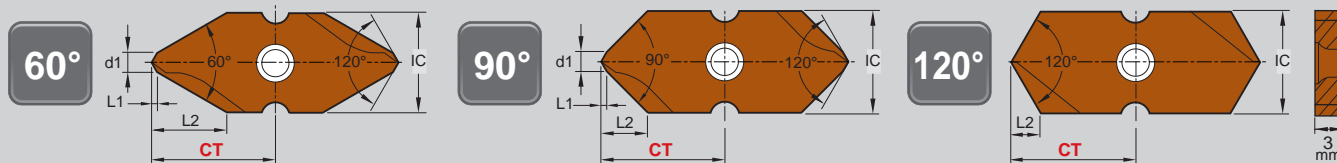

中心孔 & 埋頭孔 >>



▲ 雙刃切削設計

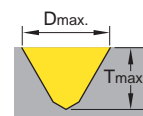

IC	角度	訂購編號	鍍層	材質	d1	L1	L2	Dmax.	Tmax.	CT ±0.025
10	60°	I9MT1003CT060-NC2057	AlTiN+TiSiN	P35	2	0.58	7.5	10	7.5	12.35
	90°	I9MT1003CT090-NC2057			2	0.58	4.6	10	4.6	
	120°	I9MT1003CT120-NC2057			-	-	2.9	10	2.9	

## ▶ 側固鋼柄 >>

- 高合金製作 · 硬度達HRC53
- 柄徑公差達h6

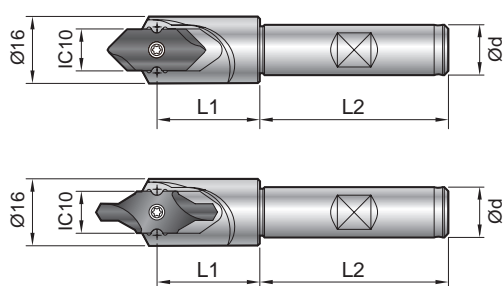

IC	訂購編號	Ød	L1	L2	螺絲 / 扳手
10	99616-IC10-12F	12	24.5	45	NS-25060 0.9Nm / NK-T7

## ▶ ER16 一體式錐柄 >>

訂購編號: 99816-IC10BH  
(請參考頁面 9-182)

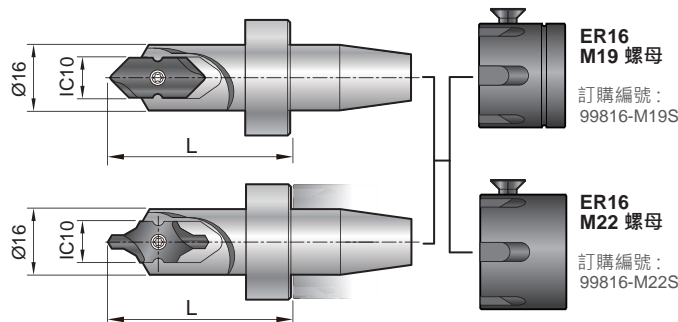

IC	訂購編號	L	螺絲 / 扳手
10	99816-IC10BH	45	NS-25060 0.9Nm / NK-T7

## ☀ 切削資料 >> (適用於中心孔 & 埋頭孔)

中心孔	工件材質	Vc (m/min.)	f (mm/rev.)			切削示意圖		
			60°	90°	120°	●	○	
	P 低碳鋼 C<0.3%	120 ~ 250	0.04 ~ 0.20	0.15 ~ 0.25	0.10 ~ 0.30	●	○	
	P 中碳鋼 C>0.3%	100 ~ 220	0.04 ~ 0.20	0.10 ~ 0.05	0.10 ~ 0.30	●	○	
	P 低合金鋼 C<0.3%	100 ~ 200	0.03 ~ 0.16	0.08 ~ 0.20	0.10 ~ 0.25	●	○	
	P 高合金鋼 C>0.3%	80 ~ 180	0.03 ~ 0.12	0.08 ~ 0.20	0.10 ~ 0.25	●	○	
	M 不鏽鋼	60 ~ 120	0.02 ~ 0.10	0.06 ~ 0.12	0.08 ~ 0.15	● ≥ 5 bar	○	
N 鋁與非鐵金屬類	150 ~ 300	0.04 ~ 0.20	0.10 ~ 0.25	0.10 ~ 0.30	●	○		
埋頭孔	工件材質	Vc (m/min.)	f (mm/rev.)			切削示意圖		
			60°	90°	120°	●	○	
			P 低碳鋼 C<0.3%	120 ~ 250	0.20 ~ 0.50		●	○
			P 中碳鋼 C>0.3%	100 ~ 220	0.20 ~ 0.40		●	○
			P 低合金鋼 C<0.3%	100 ~ 200	0.15 ~ 0.40		●	○
P 高合金鋼 C>0.3%	80 ~ 180	0.10 ~ 0.30		●	○			
M 不鏽鋼	60 ~ 120	0.08 ~ 0.30		● ≥ 5 bar	○			
N 鋁與非鐵金屬類	150 ~ 300	0.20 ~ 0.50		●	○			

● 最好的 ○ 可能的

# 中心鑽刀柄



## ▶ 側固鋼柄 >>

- 高合金製作，硬度達HRC53
- 柄徑公差達h6

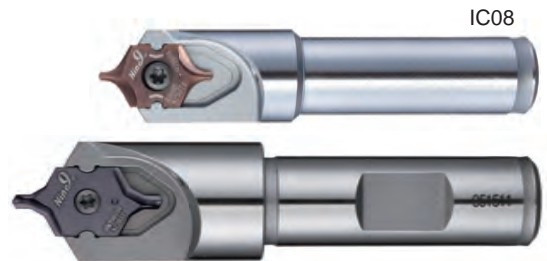
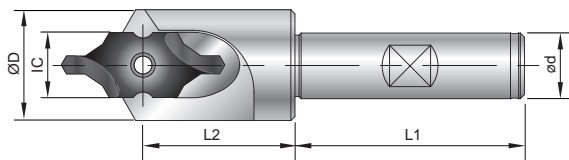

IC	訂購編號	Part No.	Ød	L1	L2	ØD	螺絲	扳手
08	99616-IC08-10F	BC10-IC08F	10	30	18.5	12	NS-25060 0.9 Nm	NK-T7
	99616-IC08-3/8F	BC3/8"-IC08F	3/8"					
10	99616-IC10-12F	SB12-IC10F	12	45	24.5	16	NS-25060 0.9 Nm	NK-T7
12	99616-IC12-16F	SB16-IC12F	16	48	30.5	21	NS-30072 2.0 Nm	NK-T9
	99616-IC12-5/8F	SB5/8"-IC12F	5/8"					
16	99616-IC16-16F	SB16-IC16F	16	48	37	27	NS-35080 2.5 Nm	NK-T15
	99616-IC16-5/8F	SB5/8"-IC16F	5/8"					
20	99616-IC20-20F	SB20-IC20F	20	50	51	32	NS-50125 5.5 Nm	NK-T20
	99616-IC20-3/4F	SB3/4"-IC20F	3/4"					
25	99616-IC25-25F	SB25-IC25F	25	56	56	43	NS-50125 5.5 Nm	NK-T20
	99616-IC25-1F	SB 1"-IC25F	1"					
★32	99616-IC32-32F	SB32-IC32F	32	60	62	54	NS-50125 5.5 Nm	NK-T20

★接受特製尺寸刀片。

## ▶ 動平衡圓柄 >>

- 高合金製作，硬度達HRC53
- G6.3 / 10,000 r.p.m.

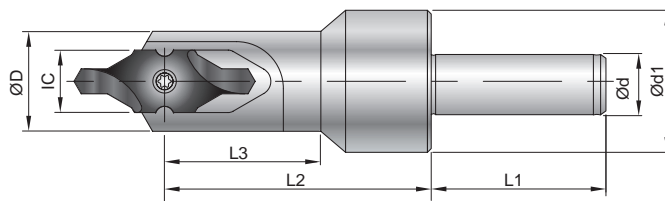

IC	訂購編號	Part No.	Ød	Ød1	L1	L2	L3	ØD	螺絲	扳手
08	99616-IC08-10B	BC10-IC08B	10	22	30	33.5	19	12	NS-25060 0.9 Nm	NK-T7
12	99616-IC12-12B	BC12-IC12B	12	34	48	51	30	21	NS-30072 2.0 Nm	NK-T9
16	99616-IC16-16B	BC16-IC16B	16	39	48	67	37	27	NS-35080 2.5 Nm	NK-T15
20	99616-IC20-20B	BC20-IC20B	20	49	50	86	51	32	NS-50125 5.5 Nm	NK-T20
25	99616-IC25-25B	BC25-IC25B	25	59	56	99	56	43	NS-50125 5.5 Nm	NK-T20

2

中心鑽



### ▶ 方型車刀座25x25 右手型 / 左手型 >>

- 適用於車床
- 刀座硬化至HRC40 · 材質穩定
- 特殊要求可訂製

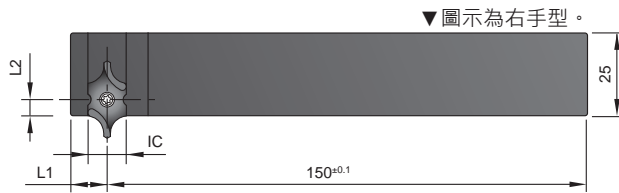

IC	訂購編號	L1	L2	螺絲	扳手
08	99616-IC08-R2525MF	8	3.25	NS-25060 0.9 Nm	NK-T7
	99616-IC08-L2525MF				
12	99616-IC12-R2525MF	11	4.9	NS-30072 2.0 Nm	NK-T9
	99616-IC12-L2525MF				
16	99616-IC16-R2525MF	13	4.9	NS-35080 2.5 Nm	NK-T15
	99616-IC16-L2525MF				

### ▶ 雙側固鋼柄 >> 特殊品

- 高合金製作 · 硬度達HRC53
- 適用於車床

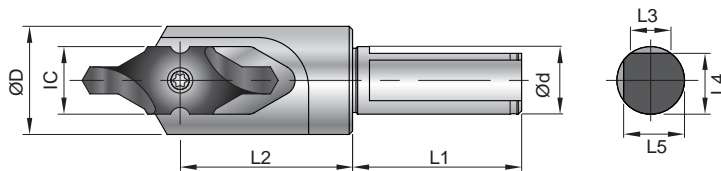

IC	訂購編號	Part No.	Ød	L1	L2	L3	L4	L5	ØD	螺絲	扳手
08	99616-IC08-10S	SL10-IC08S	10	30	18.5	6	9	9	12	NS-25060 0.9 Nm	NK-T7
12	99616-IC12-16S	SL16-IC12S	16	48	30.5	9.33	14.5	14.5	21	NS-30072 2.0 Nm	NK-T9
16	99616-IC16-16S	SL16-IC16S	16	48	37	9.33	14.5	14.5	27	NS-35080 2.5 Nm	NK-T15
20	99616-IC20-20S	SL20-IC20S	20	50	51	12	18	18	32	NS-50125 5.5 Nm	NK-T20
25	99616-IC25-25S	SL25-IC25S	25	56	56	13.57	23	23	43	NS-50125 5.5 Nm	NK-T20

2

中心鑽



# 測試基準刀片

- ▶ **主要功能** >>
  - 車床加工時，檢測刀具與主軸同心度
  - 基準刀片只有一個測試棒
  - 同心度：±0.01mm

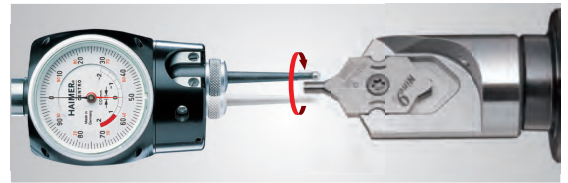

IC08	IC10	IC12	IC16	IC20
I9MT08T1-MM	I9MT1003-MM	I9MT12T2-MM	I9MT1603-MM	I9MT2004-MM

2

中心鑽

## 中心高調整刀座

- ▶ **主要功能** >>
  - 可調整刀具中心高度，避免刀具不對中心產生刀具斷裂
  - 適用中心鑽，定位鑽，車銑萬用鑽，鉸刀
  - 主結構由2個滑座組成，內套筒需鎖固切削刀具
  - 內外套筒移動，可以產生中心高度變化，進而校準刀具的中心高度

▶ **規格編號:99600-320H** >> 類型：SB32-IDER20

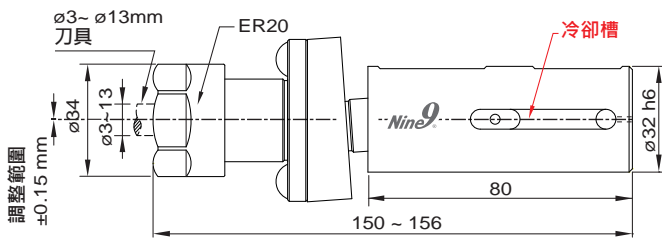

▶ **規格編號:99600-400H** >> 類型：SB40-ID16

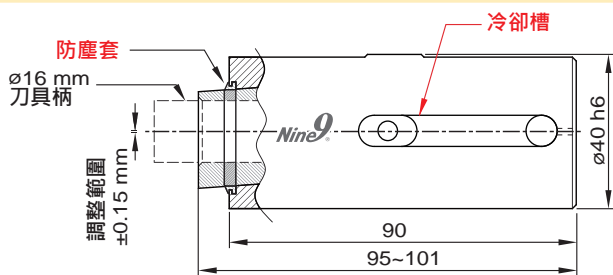

▶ **應用** >>

- CNC車床的刀座高度不精準
- 刀具中心可調高度±0.15mm
- 刀具軸向最大移動距離6mm

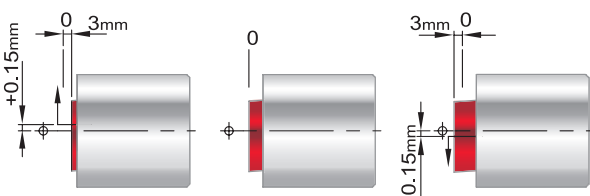

4mm 六角扳手固定螺絲



# 性能

## ▶ 最佳選擇 >>

- 高速與進給率減少切削時間。
- 特殊設計延長刀具壽命與轉換時間。

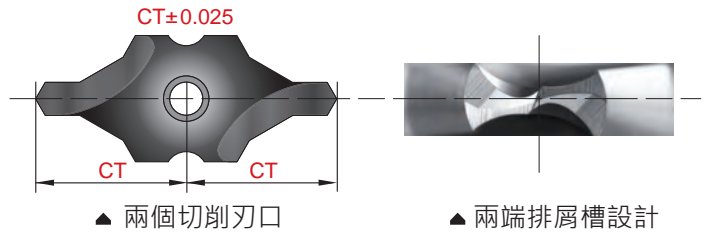

## ▶ 對照 >>

- 工件: 低合金鋼 850 N/mm<sup>2</sup>
- 機種: VMC BT40與內部冷卻。

刀桿直徑: Ø3.15 mm 鑽孔深度: 7.2 mm				
對照		i-Center	HSS 中心鑽 (TiN鍍層)	鎢鋼材質鑽頭
切削速度	m/min.	65	17	65
主軸轉速	r.p.m.	6570	1718	6570
進給速度 f =	mm/rev.	0.12	0.02	0.1
進給速度 F =	mm/min.	788.4	34.4	657
冷卻膠		外部 / 內部	外部	外部
加工時間	秒	0.55	12.5	0.65
每一刃口加工件數		7000	700	5000

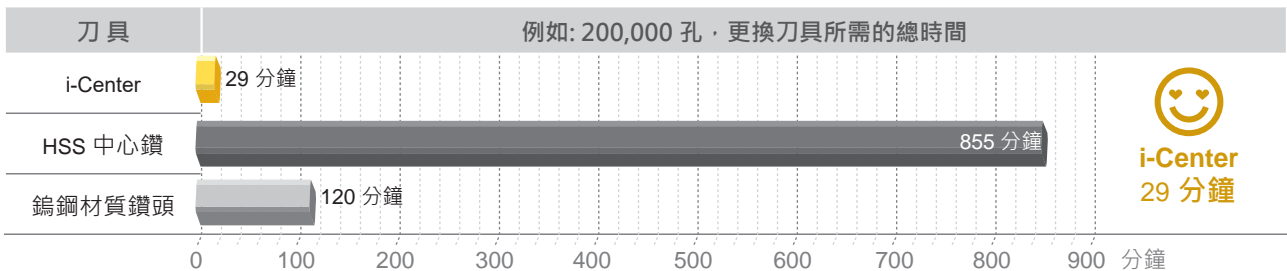
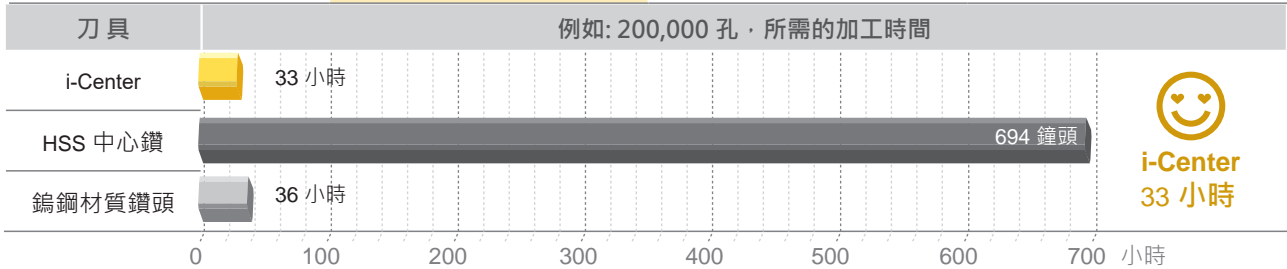

## ▶ 切削面光潔度 >>

i-Center 刀片	SCM440 材質			
19MT1603B0500 NC2033	Vc	60	m/min.	
	S	3800	r.p.m.	
	f	0.1	mm/rev.	
	F	380	mm/min.	
	Ap	13.5	mm	

```

Perthometer M1
Object
Name
#
Lt 5.600 mm
Ls Standard 2.5 µm
Lc 0.900 mm
Ra 0.562 µm
Rz 3.26 µm
Rmax 3.61 µm
RPa(0.5,-0.5) 68 /c

R Profile
Lc 0.800 mm
VER 2.50 µm
    
```

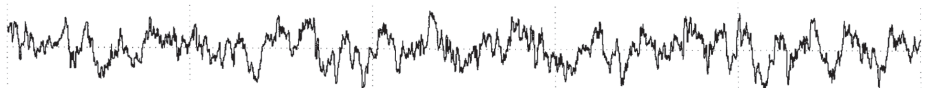

# i-Center 所需型式

## ▶ 公司 >>

## ▶ 挑戰或改善 >>

下列資訊需於客戶討論時確認

機台	
機台種類	
主軸轉速	Max. r.p.m.
主軸馬達	<input type="checkbox"/> KW <input type="checkbox"/> HP
冷卻	<input type="checkbox"/> NO
	<input type="checkbox"/> If yes, <input type="checkbox"/> 外部的 <input type="checkbox"/> 內部的 桿(psi)
原有刀具	
切削速度	<input type="checkbox"/> HSS <input type="checkbox"/> 鎢鋼
	m/min. SFM
其他	
進給率	mm/rev. inch/rev.
工件	
材質編碼	
中心孔類型	<input type="checkbox"/> R <input type="checkbox"/> A <input type="checkbox"/> B <input type="checkbox"/> C
	<input type="checkbox"/> 附件圖面
其他需求	<input type="checkbox"/> 表面粗糙度
	<input type="checkbox"/> 公差

## ▶ 特殊刀桿尺寸 >>

- 特殊刀柄請填寫D1與L4。
- 如附件中圖面
- 公制  英吋

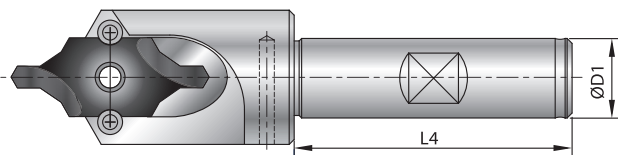

尺寸表	A1	A2	A3	ød1	ød2	ød3
尺寸						
公差	--	+0° -1°	±1°	±0.05	±0.05	--

尺寸表	L1	L2	L3	R	øD1	L4
尺寸						
公差	±0.05	±0.05	±0.05	±0.5	h6	--

## ▶ 中心孔公差 >>

- 請提供工件圖面。
- 可選擇下列其中之一。

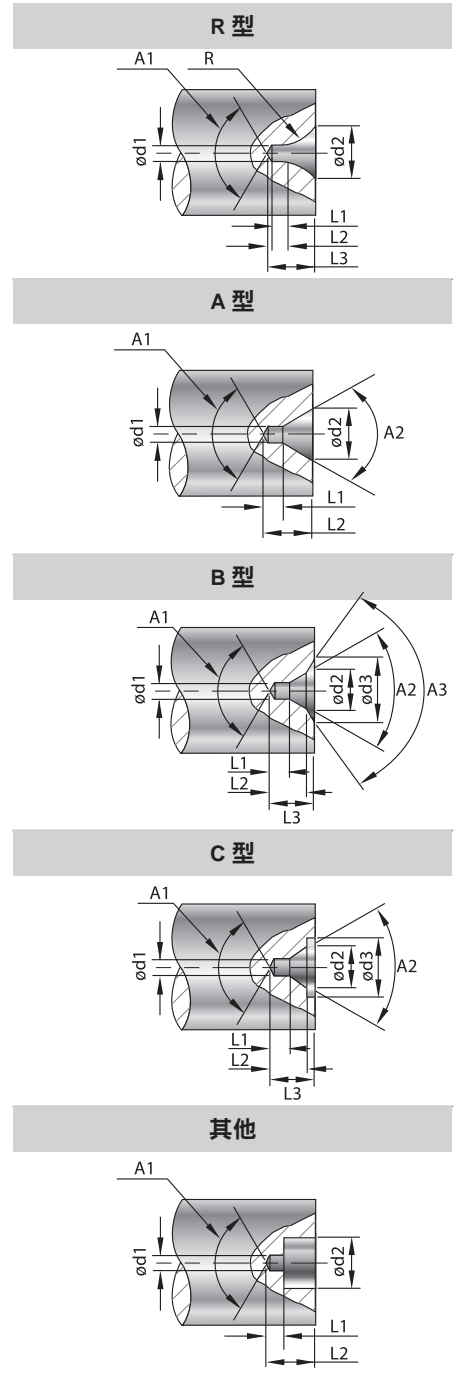

# 技術規範

## ISO 2541-1972 / DIN332

### ► 60° 中心孔

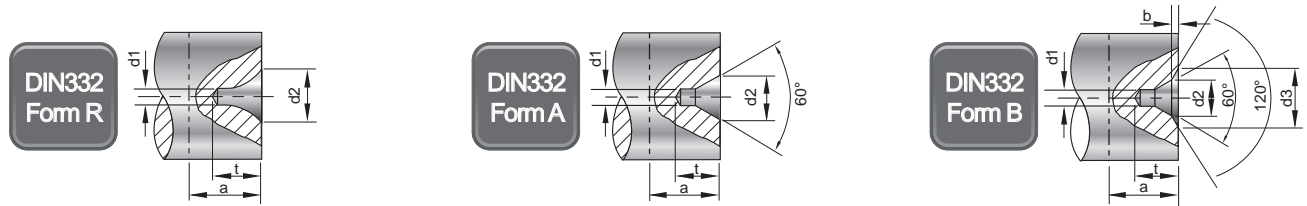

STD	DIN332 R 型 ISO 2541-1972			DIN332 A 型 ISO 866-1975			DIN332 B 型 ISO 2540 1973					
	d1	d2	t	a	d2	t	a	d2	b	d3	t	a
1	2.12	1.9	3	3	2.12	1.9	3	2.12	0.3	3.15	2.2	3.5
1.25	2.65	2.3	4	4	2.65	2.3	4	2.65	0.4	4	2.7	4.5
1.6	3.35	2.9	5	5	3.35	2.9	5	3.35	0.5	5	3.4	5.5
2	4.25	3.7	6	6	4.25	3.7	6	4.25	0.6	6.3	4.3	6.6
2.5	5.3	4.6	7	7	5.3	4.6	7	5.3	0.8	8	5.4	8.3
3.15	6.7	5.8	9	9	6.7	5.9	9	6.7	0.9	10	6.8	10
4	8.5	7.4	11	11	8.5	7.4	11	8.5	1.2	12.5	8.6	12.7
5	10.6	9.2	14	14	10.6	9.2	14	10.6	1.6	16	10.8	15.6
6.3	13.2	11.4	18	18	13.2	11.5	18	13.2	1.4	18	12.9	20
8	17	14.7	22	22	17	14.8	22	17	1.6	22.4	16.4	25
10	21.2	18.3	28	28	21.2	18.4	28	21.2	2	28	20.4	31

2

中心鑽

### ► R 型 中心孔優勢

60° 中心底座	90° 中心底座	中心孔與偏心值
----------	----------	---------

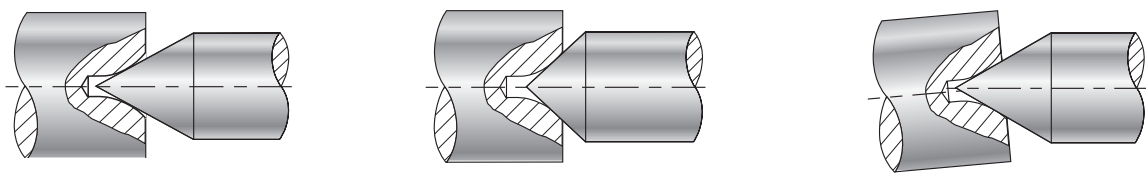

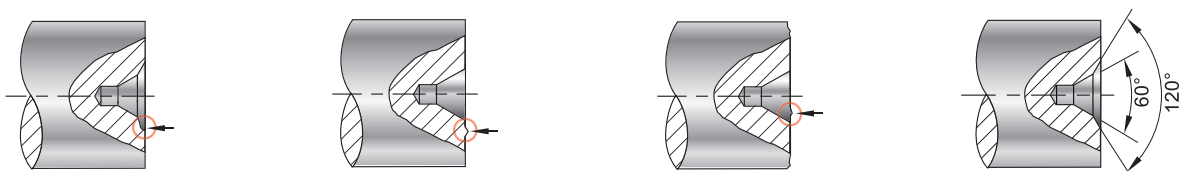

### ► B 型 中心孔優勢

避免在運送途中碰撞	毛邊	工件的粗糙表面	整體解決方案
-----------	----	---------	--------

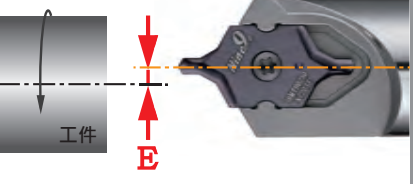
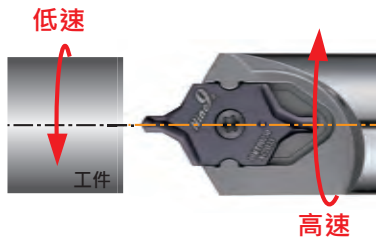
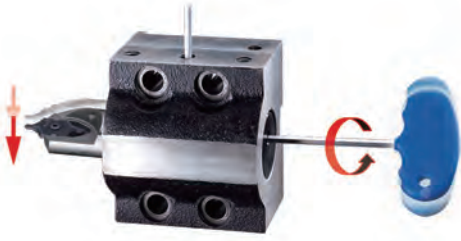

# 技術規範

► 使用之前請注意下列應用要點:

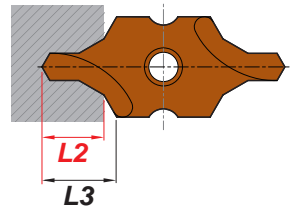
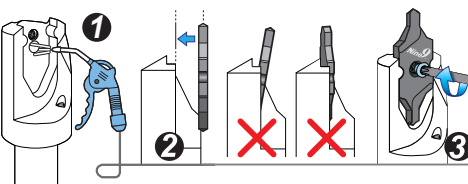
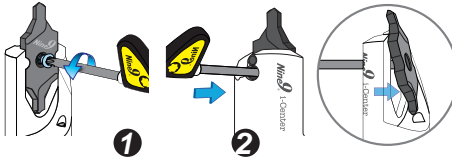
中心定位	Driving Tool	中心高調整刀座
<p>偏心值 <b>E</b> 須小於 0.02mm。</p> 	<p>低速 : 高速 1 : 3</p> 	<p>CNC車床偏心值如大於0.15mm，請使用中心高調整座。(詳見P.2-56)</p> 
中心出水孔	刀片A+B型	刀片鎖固
<p>建議使用中心出水</p> 	<p>當加工深度到達L2時，請降低轉速30%並且保持一樣的機台進給。</p> 	 <p>取下刀片</p> 

## 應用

多種定點鑽應用與產品-發動機·傳動齒輪箱·軸心·馬達·研磨零件·主軸·齒輪減速機·冷卻扇·通用...



# 切削資料

## ▶ Ø1~Ø3.15 (#2~#4)

工件材質	Vc (m/min.)	d1	IC08 / IC10		IC12			
			Ø1~1.25	Ø1.6~3.15	Ø2 (#2)	Ø2.5 (#3)	Ø3.15 (#4)	
P 低碳鋼 C<0.3% 中碳鋼 C>0.3% 低合金鋼 C<0.3% 高合金鋼 C>0.3%	< 80	S r.p.m.	2000 ~ 10000	1600 ~ 8000	1600 ~ 8000	1400 ~ 7000	1200 ~ 6000	● ○
		f mm/rev.	0.02~0.03~0.05	0.03~0.05~0.06	0.04~0.06~0.08	0.06~0.08~0.10	0.08~0.10~0.12	● ○
	< 70	S r.p.m.	2000 ~ 9000	1600 ~ 7200	1600 ~ 7200	1400 ~ 6300	1200 ~ 5400	● ○
		f mm/rev.	0.02~0.03~0.05	0.03~0.04~0.05	0.03~0.04~0.05	0.06~0.08~0.10	0.08~0.10~0.12	● ○
< 65	S r.p.m.	2000 ~ 8000	1600 ~ 6400	1600 ~ 6400	1400 ~ 5600	1200 ~ 4800	● ○	
	f mm/rev.	0.01~0.02~0.04	0.02~0.03~0.05	0.02~0.03~0.05	0.04~0.06~0.08	0.06~0.08~0.10	● ○	
< 60	S r.p.m.	1000 ~ 6000	800 ~ 4800	800 ~ 4800	700 ~ 4200	600 ~ 3600	● ○	
	f mm/rev.	0.01 ~ 0.02	0.01~0.02~0.04	0.01~0.02~0.04	0.02~0.04~0.06	0.04~0.06~0.08	● ○	
M 不鏽鋼	< 20	S r.p.m.	1000 ~ 3000	800 ~ 2400	800 ~ 2400	700 ~ 2100	600 ~ 1800	● ○
f mm/rev.		0.003 ~ 0.01	0.005 ~ 0.02	0.01 ~ 0.02	0.01~0.02~0.03	0.02~0.03~0.05	≥ 5 bar	● ○
K 鑄鐵	< 70	S r.p.m.	2000 ~ 9000	1600 ~ 7200	1600 ~ 7200	1400 ~ 6300	1200 ~ 5400	Air
f mm/rev.		0.01~0.02~0.04	0.02~0.04~0.06	0.02~0.04~0.06	0.04~0.06~0.08	0.06~0.08~0.10	Air	
N 鋁與非鐵金屬類	< 200	S r.p.m.	6000 ~ 20000	4800 ~ 16000	4800 ~ 16000	4200 ~ 14000	3600 ~ 12000	● ○
		f mm/rev.	0.01~0.02~0.03	0.01~0.02~0.04	0.01~0.02~0.04	0.02~0.03~0.05	0.02~0.04~0.06	● ○

● Best ○ Possible

## ▶ Ø4~Ø10 (#5~#10)

工件材質	Vc m/min.	d1	IC16		IC20			IC25	
			Ø4 (#5)	Ø5 (#6)	Ø6.3 (#7)	Ø8 (#8)	Ø10 (#10)		
P 低碳鋼 C<0.3% 中碳鋼 C>0.3% 低合金鋼 C<0.3% 高合金鋼 C>0.3%	< 80	S r.p.m.	1000 ~ 5000	900 ~ 4500	800 ~ 4000	700 ~ 3500	600 ~ 3000	● ○	
		f mm/rev.	0.08~0.12~0.14	0.10~0.12~0.16	0.10~0.14~0.16	0.12~0.15~0.18	0.14~0.18~0.20	● ○	
	< 70	S r.p.m.	1000 ~ 4500	900 ~ 4050	800 ~ 3600	700 ~ 3150	600 ~ 2700	● ○	
		f mm/rev.	0.08~0.12~0.14	0.10~0.12~0.16	0.10~0.14~0.16	0.12~0.15~0.18	0.14~0.18~0.20	● ○	
< 65	S r.p.m.	1000 ~ 4000	900 ~ 3600	800 ~ 3200	700 ~ 2800	600 ~ 2400	● ○		
	f mm/rev.	0.06~0.08~0.10	0.08~0.10~0.12	0.08~0.12~0.14	0.10~0.14~0.16	0.12~0.16~0.20	● ○		
< 60	S r.p.m.	500 ~ 3000	450 ~ 2700	400 ~ 2400	350 ~ 2100	300 ~ 1800	● ○		
	f mm/rev.	0.04~0.06~0.08	0.06~0.08~0.10	0.08~0.10~0.12	0.10~0.14~0.16	0.10~0.14~0.16	● ○		
M 不鏽鋼	< 25	S r.p.m.	500 ~ 1500	450 ~ 1350	400 ~ 1200	350 ~ 1050	300 ~ 900	● ○	
f mm/rev.		0.02~0.04~0.06	0.02~0.04~0.06	0.04~0.06~0.08	0.04~0.06~0.08	0.05~0.07~0.10	≥ 5 bar	● ○	
K 鑄鐵	< 70	S r.p.m.	1000 ~ 4500	900 ~ 4050	800 ~ 3600	700 ~ 3150	600 ~ 2700	Air	
		f mm/rev.	0.06~0.08~0.10	0.08~0.10~0.12	0.08~0.12~0.14	0.10~0.14~0.16	0.12~0.16~0.18	Air	
N 鋁與非鐵金屬類	< 200	S r.p.m.	3000 ~ 10000	2700 ~ 9000	2400 ~ 8000	2100 ~ 7000	1800 ~ 6000	● ○	
		f mm/rev.	0.02~0.04~0.06	0.04~0.06~0.08	0.04~0.06~0.08	0.06~0.08~0.10	0.06~0.08~0.10	● ○	

● Best ○ Possible

## ▶ 計算機台轉速及進給率

- 1.使用"d1"值與切削速Vc於資料表中計算機台轉速"S"(r.p.m.)。
- 2."F"進給率計算  $F = S \times f = \text{IPR} \times \text{r.p.m}$

公制	
$S = \frac{Vc \times 1000}{\pi \times d}$	d1 = 直徑 -mm S = 刀具轉速 -r.p.m. Vc = 切削速度 -m/min.
$F = S \times f$	f = mm/rev. F = mm/min.

英吋	
$S = \frac{(3.82 \times \text{SFM})}{d}$	d1 = 直徑-inch S = 刀具轉速-r.p.m. SFM = Surface Speed-ft./min.
$F = \text{r.p.m.} \times \text{IPR}$	f = IPR = inch/rev. F = inch/min.

